KODAK EASYSHARE CX4200

Digital Camera



User's Guide

Visit Kodak on the World Wide Web at www.kodak.com



Eastman Kodak Company

343 State Street

Rochester, New York 14650

© Eastman Kodak Company, 2002

Kodak and EasyShare are trademarks of Eastman Kodak Company.

P/N 6B8082

Camera Front

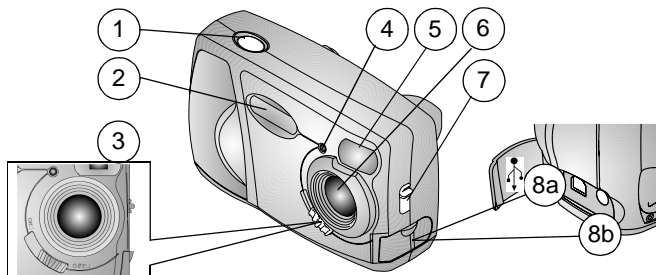

- | | | | |
|---|------------------|----|--------------------------|
| 1 | Shutter button | 6 | Lens with built-in cover |
| 2 | Flash unit | 7 | Close-up switch |
| 3 | On / Off switch | 8a | USB connector |
| 4 | Self Timer light | 8b | DC in connector |
| 5 | Viewfinder lens | | |

Camera Bottom

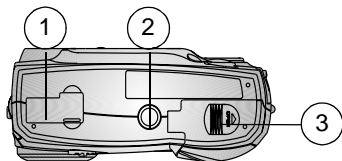

- | | | | |
|---|----------------------------------------------|---|---------------------|
| 1 | Camera Dock connector
(door shown closed) | 2 | Tripod mount socket |
| | | 3 | Battery door |

Camera Back

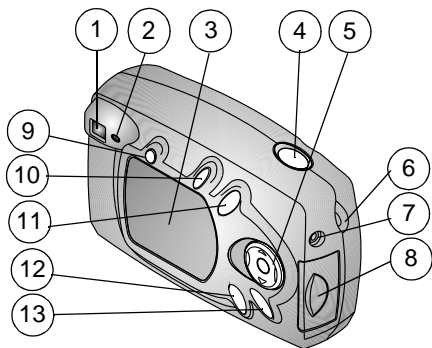

- | | |
|----------------------------|--------------------|
| 1 Viewfinder | 8 MMC/SD card door |
| 2 Ready light | 9 Flash button |
| 3 LCD | 10 Share button |
| 4 Shutter button | 11 Delete button |
| 5 4 way arrow / OK buttons | 12 Review button |
| 6 Wrist strap post | 13 Menu button |
| 7 Video out port | |

Table of Contents

1	Getting Started	1
	Install the Software First	1
	Need This Guide in Large Print?	1
	What Can I Do With My KODAK EASYSHARE CX4200 Digital Camera?	2
	What Can I Do With My Digital Pictures?	2
	Camera Package Contents	3
	Attaching the Wrist Strap	4
	Loading the Batteries	4
	Turning the Camera On and Off	5
	Using the 4-Way Arrow/OK/Zoom Button	5
	Selecting a Language.....	6
	Setting the Clock	7
	Checking Camera Status.....	8
	Inserting an MMC/SD Card	9
	Choosing Internal Memory or MMC/SD Card.....	10
	Camera Modes	11
2	Taking Pictures—Capture Mode	13
	Take a Picture Anytime	13
	Taking a Picture	13
	Liveview—Using the LCD to Frame Your Subject	14
	Quickview—Reviewing the Picture Just Taken	15
	Using the Flash.....	16

Using Digital Zoom.....	17
Taking Close-up Pictures	18
Changing Picture-Taking Options.....	19
3 Reviewing Pictures—Review Mode	25
To Enter Review Mode.....	25
To Access the Review Menus	26
Viewing Single Pictures.....	27
Viewing Multiple Pictures	27
Deleting Pictures	28
Protecting Pictures From Deletion	28
Running a Slide Show.....	29
Displaying Pictures on a Television.....	30
Copying Pictures	31
Magnifying Pictures	32
Viewing Picture Information	32
4 Tagging Pictures—Share Mode	33
When Can I Tag My Pictures?	33
To Access Share Mode/Menus.....	33
Tagging Pictures for Printing	34
Tagging Pictures for Emailing	35
Tagging Pictures as Favorites.....	36
5 Customizing Camera Settings—Setup Mode	37
To Access Setup Mode/Menus.....	37

Returning to the Previous Menu	38
Changing the Print Quantity Default	38
Turning Off Quickview	39
Turning On Liveview	39
Setting Video Out.....	40
Formatting Memory or MMC/SD Card	41
Viewing Camera Information.....	42
6 Installing the Software	43
System Requirements	43
Install the Software	45
7 Connecting to the Computer	47
Important—Before You Connect	47
Connecting to the Computer.....	47
Transferring Pictures to Your Computer	48
Printing Pictures from Your Computer	48
Printing from an MMC/SD Card	48
8 Using the KODAK EASYSHARE Camera Dock II ..	49
Camera Dock Package Contents	49
Installing the Camera Insert	50
Connecting the Camera Dock.....	51
Installing the Battery Pack in the Camera.....	52
Docking the Camera.....	53
Charging the Battery Pack.....	54
Transferring Pictures	55

Caution When Using a Tripod.....	55
Earlier Camera Dock Model.....	56
9 Troubleshooting	57
Troubleshooting—Camera	57
Troubleshooting—Camera Dock II	70
10 Getting Help	73
Helpful Web Links.....	73
Help in this User Guide	74
Software Help	74
Telephone Customer Support.....	74
11 Appendix	77
Camera Specifications.....	77
Original Factory Settings—Camera.....	79
Upgrading Your Software and Firmware.....	79
Tips, Safety, Maintenance	80
Picture Storage Capacities	81
Locating Pictures on an MMC/SD Card.....	81
Card File Naming Conventions	82
Using Your Batteries.....	83
Battery-Saving Features.....	84
Optional AC Adapter	84
Camera Dock II Specifications	85
Regulatory Information	86

1 Getting Started

Install the Software First

It is important to install the KODAK EASYSHARE Software on your computer before you connect the camera to the computer or attempt to transfer pictures. See [Chapter 6, Installing the Software](#), or the Quick Start Guide for directions.

Need This Guide in Large Print?

For a large print version of this User's Guide:

- 1 Go to <http://www.kodak.com/go/cx4200support>.
 - 2 Under Explore EasyShare, click Service and Support.
 - 3 Under Manuals/Guides, View PDF, click your language to open the User's Guide.
 - 4 On a WINDOWS-based computer or a MACINTOSH OS 8.6/9.X:
 - With the User's Guide open; from the File menu, select Print.
 - In the Print window, select Fit to Page. **This is important!**
- On MACINTOSH OS X:
- With the User's Guide open; from the File menu, select Page Setup.
 - Change Scale to 200%. **This is important!**
- 5 Print as usual.

What Can I Do With My KODAK EASYSHARE CX4200 Digital Camera?

Take Pictures  —Enjoy point-and-shoot operation with flash, close-up, and self timer features.

Review  —Display, protect, and delete pictures.

Share—Tag your pictures for printing, emailing, and as Favorites.

Set Up  —Customize your camera settings.

What Can I Do With My Digital Pictures?

Install the software from the KODAK EASYSHARE Software CD*, then:

Transfer—transfer pictures to your computer.

Share—automatically print, order online prints, and email your tagged pictures.

Organize—use Favorites to easily organize, find, and retrieve your pictures on your computer.

Edit—add special effects to your pictures, make a custom slide show, fix red-eye, crop, rotate, and much more.

Print—print your pictures directly to your home printer. Or purchase an optional KODAK Multimedia Card (MMC) or SD (Secure Digital) Card and:

- Automatically print to any printer with an MMC/SD slot
- Make prints at KODAK Picture Makers
- Contact your local retailer for the availability to print professionally from MMC/SD cards.

Refer to the Quick Start Guide or KODAK EASYSHARE Software Help for details on working with your pictures.

* MAC OS 10.0.2 and greater is required to use complete software functionality.

Camera Package Contents

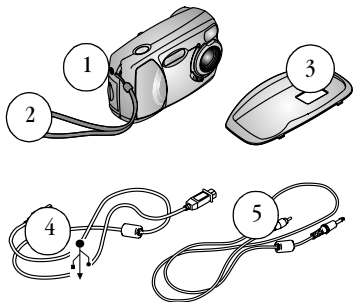

- | | | | |
|---|-----------------------|---|--------------------------------------------------|
| 1 | Camera | 4 | USB cable |
| 2 | Wrist Strap | 5 | Video Cable (for viewing pictures on television) |
| 3 | Custom Camera Insert* | | |

Also included but not shown: 2 KODAK Digital Camera Batteries, AA or a KODAK CRV3 Lithium battery; and the User's Guide or CD; Software CD; and Quick Start Guide.

NOTE: Contents subject to change. Check retail box for contents listing.

*The custom camera insert perfectly fits your camera to the optional KODAK EASYSHARE Camera Dock II. DO NOT DISCARD.
See [page 52](#) for details about purchasing and using the Camera Dock.

Attaching the Wrist Strap

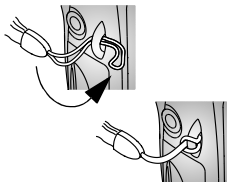

- 1 Thread the short loop of the strap through the wrist strap post.
- 2 Thread the long end of the strap through the short loop. Pull until secure.

Loading the Batteries

Two KODAK Digital Camera Batteries or one KODAK CRV3 Lithium Battery is included with your camera.*



- 1 Turn **off** the camera.
- 2 On the bottom of the camera, slide the battery door and lift to open.
- 3 Insert two KODAK Digital Camera Batteries, AA, or KODAK CRV3 battery, as shown.
- 4 Close the battery door.

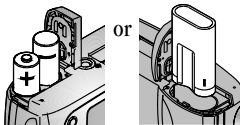

IMPORTANT BATTERY INFORMATION

For acceptable battery life and to make sure your camera operates dependably, do not use alkaline batteries.

See [page 83](#) for the types of batteries you can use in your camera.

* If your camera was packaged with a KODAK EASYSHARE Camera Dock II, see [page 52](#) for details on using the KODAK EASYSHARE Ni-MH Rechargeable Battery Pack.

Turning the Camera On and Off

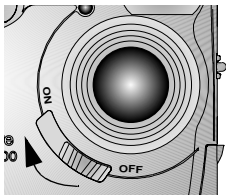

- 1 Slide the On/Off switch to the On position.
The ready light blinks green while the camera performs a self-check, then glows steady green when the camera is ready to take pictures.
- 2 To turn off the camera, slide the On/Off switch to the Off position.
The camera completes operations that are in process.

Built-in Lens Cover

The lens has a built-in cover that protects it from dust and scratches. The cover opens when the camera is turned on and closes when the camera is turned off.

Using the 4-Way Arrow/OK/Zoom Button

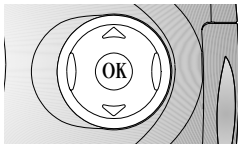

Navigating—use $\blacktriangle/\blacktriangledown$ and $\blacktriangleleft/\blacktriangleright$ to scroll through your pictures and menus.

Digital Zoom—use $\blacktriangleleft/\blacktriangleright$ to digitally zoom in or out when taking pictures. See [page 17](#).

OK—use OK to make a selection.

Selecting a Language



You can display menus and screen messages in different languages.

The Language screen is automatically displayed the first time you turn on the camera. If this is the first time the camera has been turned on, go to step 4.

To change the language after that:

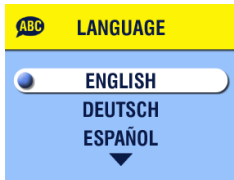
- 1 In Capture or Review mode, press the Menu button.
- 2 Highlight Setup , then press the OK button.



- 3 Highlight Language , then press the OK button.
- 4 Press / to highlight a language, then press the OK button.
- 5 Press the Menu button to turn off the menu.



*Text is displayed in the selected language.
This setting remains until you change it.*

Setting the Clock

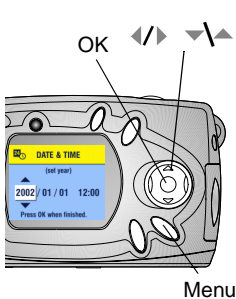

The Date & Time screen appears the first time you turn on the camera or if the battery is removed for an extended time. If this is the first time the camera has been turned on, go to step 4.

To set the date and time after that:



- 1 In Capture or Review mode, press the Menu button.
- 2 Highlight Setup Menu , then press the OK button.
- 3 Highlight Date & Time , then press the OK button.

The date format is YYYY/MM/DD in a 24-hour format.

- 4 Press  to move through the fields. Press  to adjust the settings.
- 5 Press the OK button to accept the changes.
- 6 Press the Menu button to turn off the menu.

The setting remains until you change it.

NOTE: Depending on your computer operating system, KODAK EASYSHARE Software may allow your computer to automatically update the camera clock when you connect the camera. See the KODAK EASYSHARE Software Help for details.

Checking Camera Status

To check the current camera settings push the down arrow in Capture mode or the flash button any time:

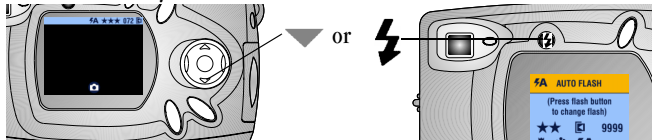

Camera Status Icons

	Date stamp	072	Pictures remaining
	Close up	Internal Card	Storage location
	Self Timer	Capture Review Share	Camera mode (icons not displayed in Liveview)
	Flash mode (page 16)	 	Low Battery Exhausted battery (blinking)*
Best ★★★ Better ★★ Good ★	Quality		Digital Zoom

Battery Status

If no battery icon appears on the LCD, the battery is fully charged.

*A blinking battery icon means the battery is too weak to power the camera. The ready light blinks red for five seconds, then the camera turns off.

Inserting an MMC/SD Card

Optional MMC/SD cards provide removable, reusable storage for pictures.



CAUTION:

The card can only be inserted one way; forcing it may damage the camera or card.

Do not insert or remove a card when the green ready light is blinking; it may damage your pictures, card, or camera.

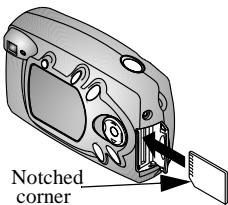

- 1 Turn off the camera.
- 2 Open the card door.
- 3 Orient the card as shown.
- 4 Push the card into the slot to seat the connector. (To remove the card, push it in, then release it. When the card is partially ejected, pull it out.)
- 5 Close the door.

See [page 81](#) for storage capacities. Purchase KODAK Multimedia Cards at your Kodak retail dealer or on our Web site at <http://www.kodak.com/go/cx4200accessories>.

Choosing Internal Memory or MMC/SD Card

The camera offers two options for storing pictures:

Internal Memory—store up to 23 pictures (at Best quality) in the 16 MB internal memory.

MMC/SD Card—store as many pictures as you like, storage capacity depends on the size of the card.

See [page 81](#) for storage capacities. Purchase KODAK Multimedia Cards at your Kodak retail dealer or on our Web site at <http://www.kodak.com/go/cx4200accessories>.



Changing Your Storage Location Setting

Use the Image Storage menu, available in Capture and Review modes, to change the setting.

- 1 Turn on the camera.
- 2 Press the Menu button.
- 3 Select Image Storage , then press the OK button.



- 4 Press $\blacktriangle/\blacktriangledown$ to highlight an option, then press the OK button:

Auto (default)—the camera uses the card if one is in the camera ; the camera uses internal memory if no card is in the camera .

Internal Memory—the camera always uses internal memory, even if a card is installed .

- 5 Highlight Continue, then press the OK button again.
The camera changes storage locations. The setting remains until you change it and applies to all camera functions (Capture, Review).
- 6 Press the Menu button to turn off the menu.

Camera Modes

The camera has four modes: Capture, Review, Share, and Setup. You can always tell which mode the camera is in:



Capture —the LCD is blank, no image is displayed. If you press the down arrow, the status bar and mode icon are displayed. See [Chapter 2, Taking Pictures—Capture Mode](#). But remember, you can press the Shutter button and take a picture anytime, no matter what mode the camera is in!

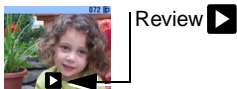

Review —the mode icon is displayed on the LCD. See [Chapter 3, Reviewing Pictures—Review Mode](#).



Share—Print, Email, and Favorites appear in the menu bar; a picture is displayed. See [Chapter 4, Tagging Pictures—Share Mode](#).



Setup—Setup mode is an option on both the Capture and Review menus. The menu bar is bright yellow; a picture is never displayed. See [Chapter 5, Customizing Camera Settings—Setup Mode](#).

2 Taking Pictures—Capture Mode

Take a Picture Anytime

The camera is in Capture mode  when you turn it on. Press the Shutter button to take a picture. But remember, you can press the Shutter button and take a picture anytime, no matter what mode the camera is in!

Taking a Picture

Before you take a picture, make sure your picture storage location is set the way you want it (see [page 10](#)).

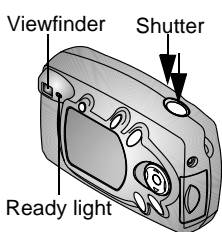

- 1 Use the Viewfinder to frame your subject. (Or press the OK button to turn on Liveview. See [page 14](#).)
- 2 Press the Shutter button half-way down to set the exposure.
- 3 Press the Shutter button completely down to take the picture.

The ready light blinks green while the picture is saved. The ready light blinks orange if the flash is recharging or if there is an auto-exposure error.



CAUTION:

Do not insert or remove a card when the green ready light is blinking. It may damage your pictures, card, or camera.

Liveview—Using the LCD to Frame Your Subject

When you turn on Liveview, the LCD displays a live image of what the lens sees. Look at the LCD to frame your picture.



- 1 Make sure the camera is in Capture mode ( on the LCD).
- 2 Press the OK button to turn on Liveview.
- 3 Frame your picture in the LCD.
- 4 Take the picture.
- 5 To turn off Liveview, press the OK button.

NOTE: Liveview quickly depletes battery power; use it sparingly. To conserve battery power, Liveview automatically turns off after one minute.

To change the Liveview setting so it is on whenever the camera is on, see [page 39](#).

Quickview—Reviewing the Picture Just Taken

After you take a picture, the LCD displays a Quickview of that picture for 5 seconds. While the picture is displayed, you can:





- Review It.** If you take no action, the picture is saved.
- Delete it.** Press the Delete button while the picture and  are displayed.

NOTE: To save battery power, you can turn off the Quickview feature. See [page 39](#).

Using the Flash

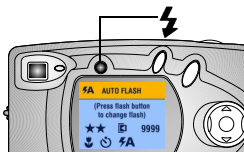
Use the flash when you take pictures outdoors in heavy shadows, at night, or indoors. Flash is effective at the distances of 1.6 to 7.9 feet (0.5 to 2.4 m).





Press the  button repeatedly to scroll through the flash options.

The flash icon displayed on the LCD is the active option.

Current camera status icons are also displayed (see [page 8](#)). The LCD screen turns off after 3 seconds.

 **Auto Flash**—flash fires when the lighting conditions require it. When the picture is taken, the camera flashes twice, once to set the exposure and once to take the picture.

 **Flash Off**—flash never fires.

 **Fill Flash**—flash fires every time you take a picture, regardless of the lighting conditions. When the picture is taken, the camera flashes twice, once to set the exposure and once to take the picture.

 **Red-eye**—flash fires once so the subject's eyes become accustomed to the flash, then again when the picture is taken. The Red-eye option remains in effect until you change it. See [page 18](#) for an exception with Close-up. When the picture is taken, the camera flashes three times, once to set the exposure, once to reduce red-eye, and once to take the picture.

NOTE: All flash options (except Red-eye) revert to Auto when the camera is turned off.

The camera uses slow shutter speeds in low-light conditions with the flash turned off. Take care to avoid camera shake; use a tripod or place the camera on a steady surface.

Using Digital Zoom

Use Digital Zoom to zoom in two times closer to your subject. The lens does not move during Digital Zoom.

IMPORTANT: *You may notice a decrease in printed image quality when using Digital Zoom.*



- 1 Press the OK button to turn on Liveview.
- 2 Press  to activate the Digital Zoom.

The LCD displays the zoomed image and the Digital Zoom icon .

- 3 Use the LCD to frame your subject, then take the picture. You must use Liveview to take the picture because the Zoom is only displayed through the LCD and not the viewfinder.

NOTE: Digital Zoom is turned off when you press the OK button, turn off the camera, turn Close-up on or off, or when the camera enters Auto power-off.

Taking Close-up Pictures

The Close-up setting helps you gain sharpness and detail at close range. The Close-Up focus distance is 7.9 to 11.8 in. (200 to 300 mm).

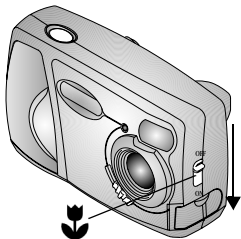

To turn on Close-up:

- 1 Make sure the camera is in Capture mode.
- 2 Locate the Close Up control on the side of the camera, , then move the switch to the On position.

The Close-up icon  appears in the status bar and the LCD automatically enters Liveview.

- 3 Use the LCD to frame your subject and take the picture as usual.

NOTE: If the flash is set to Red-eye when you turn on Close-up, the flash setting changes to Auto; the flash then changes back to Red-eye when you turn off Close-up. If you change the flash setting while in Close-up, the new setting remains when you turn off Close-up.

Changing Picture-Taking Options

Use the Capture menus to change picture-taking options. If you are in Review, Share, or Setup modes you must return to Capture mode before you can access the Capture menus.

To Return to Capture From Another Mode







To return to Capture from:

- Any mode, press the Shutter button to take a picture and revert to Capture.
- Review mode, press the Review button.
- Share mode, press the Share button.
- Setup mode, press the Menu button.

To Access the Capture Menu

- 1 In Capture mode (LCD is blank, no picture is displayed), press the Menu button.
- 2 Press the Menu button to turn off the menu.

Capture Menus

- | | |
|--------------------------------------------------------------------------------------------------------------------------|-----------------------------------------------------------------------------------------------------------------------|
|  Self Timer (page 20) |  Date Stamp (page 23) |
|  Image Storage (page 10) |  Orientation Sensor (page 24) |
|  Exposure Compensation (page 21) |  Setup (page 37) |
|  Quality (page 22) | |

Putting Yourself in the Picture

The Self Timer creates a 10-second delay between the time you press the Shutter button and the time the picture is taken.



- 1 In Capture mode, press the Menu button.
- 2 Highlight Self Timer , then press the OK button.
- 3 Highlight On, then press the OK button.
- 4 Press the Menu button to turn off the menu screen.

Press Shutter

Self Timer light

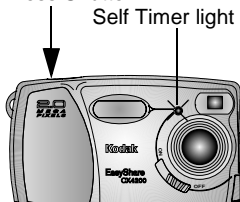

- 5 Place the camera on a flat surface or use a tripod.
- 6 Press the Shutter button.

The red Self Timer light turns on for 8 seconds, then blinks for 2 seconds. The picture is taken.

The Self Timer turns off after you take the picture.





Setting Exposure Compensation

Use Exposure Compensation to control how much light is allowed into the camera. The exposure range is +2 to -2 in 1/2-step increments.

NOTE: This setting is ideal for controlling pictures in which the light source is behind the subject (backlit), or for correcting pictures that are too light or too dark.

- 1 In Capture mode, press the Menu button.
- 2 Highlight Exposure Compensation , then press the OK button.



- 3 Press /  to select the Exposure Compensation setting.
 - If your pictures are too light, press  to decrease (-) the value.
 - If your pictures are too dark, press , to increase (+) the value.
- 4 Press the OK button to accept the change and return to the menu screen.
- 5 Press Menu to exit the menu screen.

This setting remains until you change it.

Setting Picture Quality

Use the Quality setting to select a picture resolution:

- 1 In Capture mode, press the Menu button.
- 2 Highlight Quality ★, then press the OK button.

The active Quality setting appears in the top left corner.



- 3 Highlight an option:

Best ★★★ —(2 MP) for printing up to 8 x 10 in. (20.3 x 25.4 cm); produces highest picture resolution, more detail, and largest file sizes.

★★★ *appears in the status bar.*

Better ★★ —(1 MP) for printing up to 5 x 7 in. (12.7 x 17.8 cm); pictures are medium resolution with smaller file sizes.

★★ *appears in the status bar.*

Good ★ —(0.5 MP) for emailing or screen display; pictures are lowest resolution with smallest file sizes.

★ *appears in the status bar.*

- 4 Press the OK button.
- 5 Press the Menu button to turn off the menu screen.

This setting remains until you change it.

Placing the Date on Pictures

Use Date Stamp to imprint the date on your pictures.

- 1 Make sure the camera clock is set to the correct date (page 7).
- 2 In Capture mode, press the Menu button.
- 3 Highlight Date Stamp , then press the OK button.



- 4 Highlight an option:
 - Off**
 - YYYY MM DD**
 - MM DD YY**
 - DD MM YYYY**
- 5 Press the OK button.
- 6 Press the Menu button to turn off the menu.

The current date is printed in the bottom right corner of new pictures. This setting remains until you change it.

Turning Off the Orientation Sensor

If you turn the camera when you take a picture (for example, to take a lengthwise or portrait picture), the Orientation Sensor repositions the picture so it is displayed correct side up during Quickview, Review, picture transfer, multi-up, and in video-out display.

The Orientation Sensor is turned on as the factory default. You can turn it off so that pictures are displayed in the same orientation as they are taken.

- 1 In Capture mode, press the Menu button.
- 2 Highlight Orientation , then press the OK button.
- 3 Highlight Off, then press the OK button.
- 4 Press the Menu button to turn off the menu.

This setting remains until you change it.

3 Reviewing Pictures—Review Mode

Use Review mode  to view and work with the pictures that are stored in internal memory or on a card. But remember, you can press the Shutter button and take a picture anytime, no matter what mode the camera is in!

NOTE: Reviewing pictures on the LCD quickly depletes battery power. An optional AC adapter is available (see [page 84](#)).

To Enter Review Mode

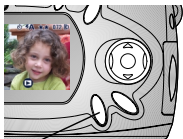









Review button

- 1 Press the Review button.
The last picture you took or reviewed is displayed. The Review icon  appears at the bottom of the LCD.
- 2 Press the Review button again to exit Review and return to Capture mode.

The icons displayed with the picture indicate applied features.

Picture Information Icons

		 2		072	 Internal memory  Memory Card
Email	Favorite	Print tag, # of copies	Protected	Picture number	Picture Location

 Review		
Mode indicator	Low battery	Exhausted battery (blinking)

To Access the Review Menus

Use the Review menus to work with the pictures that are stored in internal memory or on a card.

- 1 Press the Review button.
- 2 Press the Menu button.
- 3 Press the Menu button to turn off the menus.

Review Menus



Protect (page 28)



Magnify (page 32)



Image Storage (page 10)



Multi-up (page 27)



Slide Show (page 29)



Picture Information (page 32)



Copy (page 31)



Setup (page 37)

Viewing Single Pictures



- 1 Press the Review button.
The camera displays the last picture that was taken or reviewed.
- 2 Press ◀/▶ to scroll backward or forward through the pictures.

Viewing Multiple Pictures



- 1 Press the Review button.
- 2 Press ▼.
Nine pictures (thumbnails) are displayed at once.
- 3 Press ▲/▼ to display the previous or next row of thumbnails.
- 4 Press ◀/▶ to scroll through the thumbnails one at a time.
The selected picture is highlighted in yellow.
- 5 Press the OK button to display a single view of the selected picture.

Viewing Multiple Pictures—Review Menu

You can also view multiple pictures through the Review menu, Multi-up option.

- 1 Press the Review button, then press the Menu button.
- 2 Highlight Multi-up , then press the OK button.
Nine pictures (thumbnails) are displayed at once.
- 3 Navigate through the thumbnails as described above.

Deleting Pictures



- 1 Press the Review button.
- 2 Select a picture in single view or highlight a picture in multiple view, then press the Delete button.

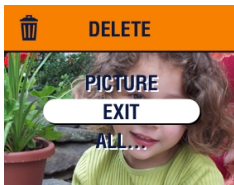

- 3 Highlight an option, then press the OK button:
 - PICTURE**—deletes the displayed picture.
 - EXIT**—exits the Delete screen.
 - ALL**—deletes all pictures from your current storage location.

NOTE: Protected pictures cannot be deleted; remove protection before deleting (page 28).

Protecting Pictures From Deletion

- 1 Press the Review button, then locate the picture to protect.
- 2 Press the Menu button.

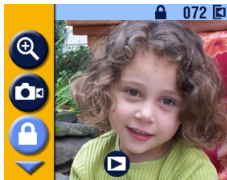

- 3 Highlight Protect , then press the OK button.

The Protect icon  appears with the protected picture whenever it is displayed in the status bar. The picture cannot be deleted. (Formatting deletes even protected pictures, see page 41).

- 4 To remove protection, press the OK button again.
- 5 Press the Menu button to turn off the menu.

Running a Slide Show

Use the Slide Show to display your pictures on the LCD in the order in which you took them. To run a slide show on a television or other external device, see [page 30](#).

Starting the Slide Show

- 1 Press the Review button, then press the Menu button.
- 2 Highlight Slide Show , then press the OK button.
- 3 Highlight Begin Show, then press the OK button.



The pictures are each displayed once in the order in which you took them. Then the camera returns to the Menu screen. See [Turning On Loop, page 30](#), for continual display.

- 4 To cancel the Slide Show, press the OK button.

NOTE: If you connect or disconnect the video cable while a slide show is running, the slide show stops.

Changing the Display Interval

The default setting displays each picture for 5 seconds. You can increase the display interval to up to 60 seconds.

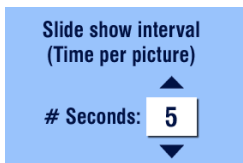

- 1 On the Slide Show menu, highlight Interval, then press the OK button.
- 2 Press $\blacktriangle/\blacktriangledown$ to select a display interval. To scroll through the seconds quickly, press and hold $\blacktriangle/\blacktriangledown$.
- 3 Press the OK button.

The Interval setting remains until you change it.

Turning On Loop

When you turn on Loop, the slide show is continuously repeated.

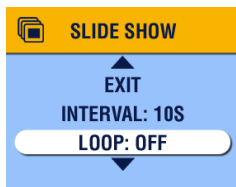

- 1 On the Slide Show menu, press \blacktriangledown to scroll down to Loop; highlight Loop, then press the OK button.
- 2 Highlight On, then press the OK button.

When you start a slide show, it repeats continuously until you cancel it by pressing the OK button or until battery power is exhausted.

The Loop setting remains until you change it.

Displaying Pictures on a Television

You can run a slide show or display your pictures on a television, computer monitor, or digital projector (any device equipped with a video input).

NOTE: Ensure that the Video Out setting is correctly set to NTSC or PAL (see [page 40](#)).

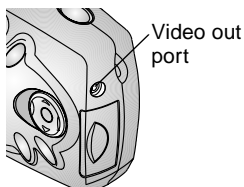

- 1 Connect the video cable from the video out port on the camera to the video in port on the television. (Refer to your television User's Guide for details on video in setup.)

The camera LCD turns off; the television screen acts as the camera display.

- 2 You can now use the television screen to review your pictures in single or multiple views, run a slide show, or do anything on the television screen that you can do on the camera LCD.

Copying Pictures

You can copy pictures from a card to internal memory, or from internal memory to a card.

Before you copy make sure that:

- A card is inserted in the camera.
- The camera's picture storage location is set to the location **from** which you are copying. See [Choosing Internal Memory or MMC/SD Card](#), page 10.

Copy pictures:

- 1 Press the Review button, then press the Menu button.
- 2 Highlight Copy , then press the OK button.



- 3 Highlight an option:
 - PICTURE**—copies the current picture from your selected storage location to the other location.
 - EXIT**—returns to the Copy screen.
 - ALL**—copies all pictures from your selected storage location to the other location.
- 4 Press the OK button.

A progress bar monitors the copy process.





NOTE: Pictures are copied, not moved. To remove the pictures from the original location after they are copied, delete them (see [page 28](#)).

Tags and protection are not copied. Print, email, and Favorite tags are not copied with the picture (see [page 34](#) to re-apply tags). Protection settings are not copied (see [page 28](#) to re-apply protection).

Magnifying Pictures

- 1 Press the Review button, then press the OK button.

The picture is displayed at 2X magnification. The Magnify icon  and the magnification value are displayed on the screen.

- 2 Press the OK button again to display the picture at 4X magnification.
- 3 Press / / to view different parts of the picture.
- 4 Press the OK button again to redisplay the picture at the original size.



NOTE: You can also magnify pictures through the Magnify menu: press the Review button, press the Menu button, highlight Magnify , then press the OK button.

Viewing Picture Information



- 1 Press the Review button, then press the Menu button.
- 2 Highlight the Picture Info menu , then press the OK button.

The information about the displayed picture is view-only and includes: file name, location of the file if stored on a card (there are no directories in internal memory), date and time the picture was taken, and the quality setting.

- 3 Press / to display the previous/next picture, with that picture's information.
- 4 To exit Picture Info, press the OK button.

4 Tagging Pictures—Share Mode

Press the Share button to tag your pictures as Favorites and for automatic printing and emailing. But remember, you can press the Shutter button and take a picture anytime, no matter what mode the camera is in!

NOTE: MACINTOSH OS 8.6/9.x do not support the Share button functions. OS X is recommended for full functionality.

When Can I Tag My Pictures?

You can tag pictures whenever they are displayed on the LCD in Review mode (see [page 25](#))

To Access Share Mode/Menus

- 1 Press the Share button.
- 2 Press the Share button again to exit Share mode and return to Capture or Review mode.

Share Menus



Print ([page 34](#))



Print All ([page 34](#))



Email ([page 35](#))





Cancel Prints ([page 34](#))

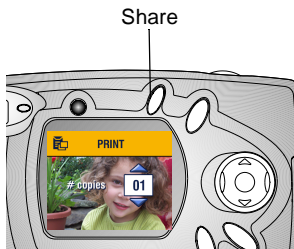

Favorite ([page 36](#))

Tagging Pictures for Printing



- 1 Locate a picture, then press the Share button.
- 2 Highlight Print  and press the OK button.
- 3 Press $\blacktriangle/\blacktriangledown$ to select the number of copies (0-99). Zero removes the tag for that picture.

The Print icon  appears with the picture.

The default quantity is one. To change the default, see [page 38](#).

- 4 To tag all pictures on the card or in internal memory, highlight Print All, press the OK button, then indicate the number of copies as described above. Print All is not available in Quickview.
- 5 To remove the print tagging for all pictures on the card or in internal memory, highlight Cancel Prints, then press the OK button. Cancel Prints is not available in Quickview.
- 6 Press the Share button to return to Capture mode.

Printing Tagged Pictures

See [page 48](#) for information on printing your digital pictures.

Tagging Pictures for Emailing

First, use KODAK EASYSHARE Software to create an email address book on your computer, then copy up to 32 email addresses to the camera's internal memory. See the KODAK EASYSHARE Software Help for details.

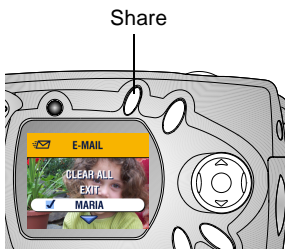

- 1 Locate a picture, then press the Share button.
- 2 Highlight Email , then press the OK button.
- 3 Press \blacktriangle / \blacktriangledown to highlight an email address, then press the OK button.

To send the picture to more than one person, repeat step 3 for each address.

Selected addresses are noted with a check mark, and the email icon  appears with the picture.

- 4 To remove a selection, highlight a checked address and press the OK button. To remove all email selections, select Clear All.
- 5 Highlight Exit, then press the OK button.
Your selections are saved.
- 6 Press the Share button to return to Capture mode.

Emailing Tagged Pictures

When you transfer the tagged pictures to your computer, the KODAK EASYSHARE Software email screen opens and lets you immediately send the pictures to the addresses you specified. See the KODAK EASYSHARE Software Help for details on address books and emailing.

Tagging Pictures as Favorites



- 1 Locate a picture, then press the Share button.
- 2 Highlight Favorite , then press the OK button.

The Favorite icon  appears with the picture.

- 3 To remove the tag, press the OK button again.
- 4 Press the Share button to return to Capture mode.

Using Favorites on Your Computer

See the KODAK EASYSHARE Software Help for details on retrieving and organizing Favorites on your computer.

5 Customizing Camera Settings—Setup Mode

Use Setup mode  to customize your camera settings. You can access Setup mode two ways: in the Capture menu screen and the Review menu screen.

In Capture mode

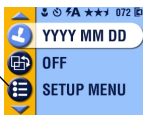

In Review mode



To Access Setup Mode/Menus

- 1 In Capture or Review mode, press the Menu button.
- 2 Highlight Setup  and press the OK button.
- 3 Press the Menu button to turn off the Setup menu and return to Capture or Review mode.

Setup Menus



Return ([page 38](#))



Default Print Quantity ([page 38](#))



Quickview ([page 39](#))



Liveview ([page 39](#))



Date/Time ([page 7](#))



Video Out ([page 40](#))



Language ([page 6](#))



Format ([page 41](#))



About ([page 42](#))

Returning to the Previous Menu

The Return feature lets you return to the menu screen from which you entered the Setup menu.

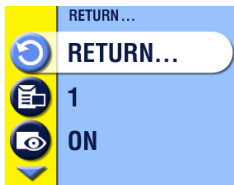

- In the Setup menu, highlight Return , then press the OK button.



You are returned to the menu screen from which you entered Setup: Capture or Review.

Changing the Print Quantity Default

The Default Print Quantity setting determines the value that is displayed on the Share Print screen (see [page 34](#)). The default value is one.

- 1 In Capture or Review mode, press the Menu button.
- 2 Highlight Setup , then press the OK button.





- 3 Highlight Default Print Quantity , then press the OK button.
- 4 Press / to indicate the new default quantity, then press the OK button.
- 5 Press the Menu button to turn off the menu.

This setting remains until you change it.

Turning Off Quickview

After you take a picture, Quickview displays it on the LCD for 5 seconds (see [page 15](#)). The default setting is on. To save battery power, turn off Quickview:

- 1 In Capture or Review mode, press the Menu button.
- 2 Highlight Setup , then press the OK button.
- 3 Highlight Quickview , then press the OK button.
- 4 Highlight Off, then press the OK button.
- 5 Press the Menu button to turn off the menu.

The picture is not automatically displayed on the LCD after you take it. To see the picture, press the Review button.



This setting remains until you change it.

Turning On Liveview

The Liveview feature displays a live image on the LCD so you can frame your picture in the LCD instead of the Viewfinder (see [page 14](#)). The default setting is Off, which means that you must press the OK button to see the live image.

IMPORTANT: *Liveview quickly depletes battery power; use it sparingly.*

Turn on Liveview:

- 1 In Capture or Review mode, press the Menu button.
- 2 Highlight Setup , then press the OK button.
- 3 Highlight Liveview , then press the OK button.
- 4 Highlight On, then press the OK button.



The live image is displayed whenever the camera is on. Liveview automatically turns off after one minute to conserve battery power. You can manually turn it back on by pressing the OK button.

- 5 Press the Menu button to turn off the menu.

This setting remains until you change it.

Setting Video Out

The Video Out feature lets you match the camera's video signal to the standard for your location. Video Out must be set correctly to run a slide show on an external device (see [page 30](#)).

- 1 In Capture or Review mode, press the Menu button.
- 2 Highlight Setup , then press the OK button.
- 3 Highlight Video Out , then press the OK button.

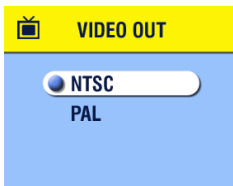

- 4 Highlight an option:
NTSC—used in the United States and Japan and most countries outside of Europe.
PAL—used in European countries.
- 5 Press the OK button to accept the change and return to the Setup menu.
- 6 Press the Menu button to turn off the menu.
This setting remains until you change it.

Formatting Memory or MMC/SD Card



CAUTION:

Formatting deletes everything in memory or on the card, even protected pictures and the internal email address book. Removing a card during formatting may damage the card.

- 1 In Capture or Review mode, press the Menu button.
- 2 Highlight Setup , then press the OK button.

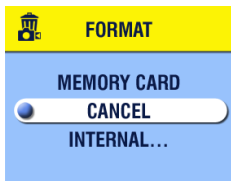

- 3 Highlight Format , then press the OK button.

- 4 Highlight an option:

MEMORY CARD—deletes everything on the card, even protected pictures, and reformats the card for use in the camera.

CANCEL—exits without making a change.

INTERNAL—reformats and deletes everything in internal memory, even protected pictures and the address book.

- 5 Press the OK button.
- 6 Highlight Continue, then press the OK button.



Once formatting begins, it is completed even if you turn off the camera or change modes.

When the formatting is complete, the Setup menu is redisplayed.

- 7 Press the Menu button to turn off the menu.

Viewing Camera Information

The About feature displays information that is helpful if you need to call for service on your camera.

- 1 In Capture or Review mode, press the Menu button.
- 2 Highlight Setup , then press the OK button.
- 3 Highlight About , then press the OK button.
The camera information is view-only.
- 4 Press the Menu button to turn off the menu.



6 Installing the Software

System Requirements

WINDOWS System Requirements

- Personal computer for WINDOWS 98, 98SE, ME*, 2000*, or XP
- 233 MHz processor or greater
- 64 MB of available RAM (128 MB for WINDOWS XP)
- 200 MB of available hard disk space
- CD-ROM drive
- Available USB port
- Color monitor with a minimum resolution of 800 x 600 pixels; High Color (16-bit) or True Color (24-bit) recommended
- Internet access for online printing and emailing
 - * For WINDOWS ME and 2000 you must have Administrator rights to install software.

MACINTOSH OS X System Requirements

- POWER MAC G3, G4, G4 Cube; iMAC; POWERBOOK G3, G4; iBOOK computer
- MACINTOSH OS 10.1.2, minimum
- 128 MB of available RAM
- 200 MB of available hard disk space
- CD-ROM drive
- Built-in USB port
- Color monitor with a minimum resolution of 800 x 600 pixels; thousands or millions of colors recommended
- Internet access for online printing and emailing

MACINTOSH OS 8.6/9.x System Requirements

- PowerPC-based MACINTOSH computer
- MACINTOSH OS 8.6/9.x
- 64 MB of available RAM
- 200 MB of available hard disk space
- CD-ROM drive
- Built-in USB port
- Color monitor with a minimum resolution of 800 x 600 pixels; thousands or millions of colors recommended
- Internet access for online printing and emailing

NOTE: OS 8.6/9.x do not support the Share button functions. OS X is recommended for full functionality.

Install the Software

For information on the software applications included on the KODAK EASYSHARE Software CD, see the Quick Start Guide or KODAK EASYSHARE Software Help.

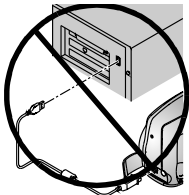

CAUTION:

Do not install the KODAK EASYSHARE Software with the camera or Camera Dock connected to the computer. It may cause the software to load incorrectly. If you have already connected, disconnect the camera or Camera Dock before you proceed.

- 1 Before you begin, close all software applications that are open on your computer.
- 2 Place the KODAK EASYSHARE Software CD into the CD drive.
- 3 Load the software:

On a WINDOWS-based computer—if the first install window does not appear, choose Run from the Start menu and type `d:\setup.exe` (if `d` is the drive letter that contains the CD).

On MACINTOSH OS 8.6/9.x—on the install window, click Continue.

On MACINTOSH OS X—double-click the CD icon on the desktop, then click the Install icon.

- 4 Follow the on-screen instructions to install the software. If prompted, restart the computer when the installation is complete.
 - Select Typical to automatically install the needed applications on WINDOWS-based computers. Select Custom to choose the applications to install.
 - Select Easy to automatically install the needed applications on MACINTOSH computers running OS 8.6/9.x.
 - Follow the on-screen instructions to install the software on MACINTOSH computers running OS X.

NOTE: When prompted, take a few minutes to electronically register your camera and software. This lets you receive information regarding software updates and registers some of the products included with the camera. You must be connected to your Internet service provider to register electronically.

For further installation help, see the Quick Start Guide.

7 Connecting to the Computer

Important—Before You Connect

Install the software from the KODAK EASYSHARE Software CD BEFORE you connect the camera or Camera Dock to the computer.

Connecting to the Computer

You can transfer your pictures from the camera to the computer using either the camera alone or the optional KODAK EASYSHARE Camera Dock or Camera Dock II. See [page 51](#) for connecting with a Camera Dock.

Connecting With the USB Cable

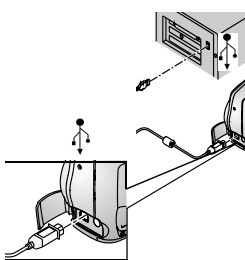

- 1 Turn off the camera.
- 2 Plug the labeled (USB) end of the USB cable into the labeled USB port on your computer. See your computer User's Guide for details.
- 3 Plug the other end of the USB cable into the labeled USB port on the camera.

An optional AC adapter is available for your camera; it saves battery power when transferring pictures (see [page 84](#)).

NOTE: You can also use a KODAK SD Multimedia Card Reader-Writer to transfer your pictures. See your KODAK retail dealer or visit our Web site at <http://www.kodak.com/go/cx4200accessories>.

Transferring Pictures to Your Computer

For details on transferring pictures, see the Quick Start Guide or the KODAK EASYSHARE Software Help.

Printing Pictures from Your Computer

For details on printing pictures from your computer, and ordering prints online, see the Quick Start Guide or the KODAK EASYSHARE Software Help.

Printing from an MMC/SD Card

- Automatically print tagged pictures when you insert your card into a printer with an MMC/SD slot. See your printer user guide for details.
- Contact your local retailer for the availability to print professionally from MMC/SD cards.
- Make your own prints at a KODAK Picture Maker with a built-in MMC/SD slot.

8 Using the KODAK EASYSHARE Camera Dock II

The KODAK EASYSHARE Camera Dock II (Camera Dock) makes it easy to transfer your pictures to the computer. The Camera Dock is also a rapid battery charger for the included KODAK EASYSHARE Ni-MH Rechargeable Battery Pack, and supplies power to the camera.

To keep the Battery Pack charged and the camera always ready to take pictures, store your camera in the Camera Dock.

Camera Dock Package Contents

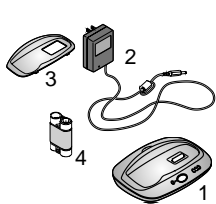

- 1 Camera Dock
- 2 AC power adapter, 7-Volt

Some AC adapters may be different from the one pictured.

- 3 Universal insert
- 4 KODAK EASYSHARE Ni-MH Rechargeable Battery Pack
- 5 Quick Start Guide (not shown)

If a Camera Dock was not included with your camera, you can purchase one at your KODAK retail dealer or visit our Web site at <http://www.kodak.com/go/cx4200accessories>.



CAUTION:

Do not use the Digital Camera AC Adapter, 3-Volt with a KODAK EASYSHARE Camera Dock; it is NOT compatible.

Installing the Camera Insert

KODAK EASYSHARE digital cameras are packaged with a custom camera insert, which is used to perfectly fit the camera to the Camera Dock.

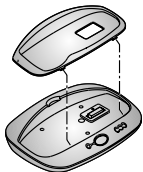

- 1 Place the front tabs on the custom insert into the slots in the Camera Dock cavity.
- 2 Fit the insert down into the cavity and snap the insert into place.

If You Do Not Have the Custom Insert

If you do not have the custom insert that was included with your camera, use the universal insert that is included with the Camera Dock II. The universal insert works with all KODAK EASYSHARE cameras, but it does not fit the cameras perfectly.

To order a custom camera insert visit our Web site at <http://www.kodak.com/go/cx4200accessories>.

Connecting the Camera Dock

After the KODAK EASYSHARE Software is loaded (see [page 45](#)), connect the Camera Dock to your computer and to an external power source. You will need:

- the USB cable included with your camera
- the AC adapter, 7-Volt included with the Camera Dock

IMPORTANT: *Make sure your camera is NOT in the Camera Dock when you are connecting to power and the computer.*

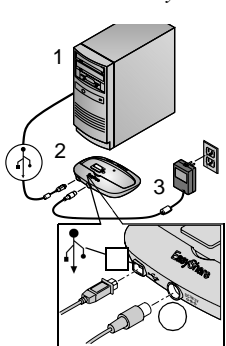

- 1 Plug the labeled (A) end of the USB cable into the labeled USB port on your computer. See your computer User's Guide for details.
- 2 Plug the other end of the USB cable into the square USB connector on the back of the Camera Dock.
- 3 Plug the AC adapter into the round power connector on the back of the Camera Dock and into a power outlet.

Your AC adapter may be different from the one pictured or may have additional plugs. Use the plug that accommodates your type of power outlet.

Leave the Camera Dock connected to the computer for easy access for transferring pictures and charging the Battery Pack.

IMPORTANT: *Use only the AC adapter, 7-Volt included with the Camera Dock. Other adapters may cause damage to your camera, Camera Dock, or computer.*

Installing the Battery Pack in the Camera

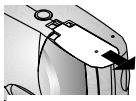

- 1 Open the battery door on the bottom of the camera.
- 2 Install the Battery Pack as illustrated.

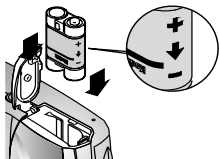

CAUTION:

The Battery Pack can only be inserted into the camera in the orientation shown. If the Battery Pack does not easily install, reposition it and try again. **DO NOT FORCE IT.** Doing so can damage your camera.

- 3 Close the battery door.

IMPORTANT: *The Battery Pack is not charged when you receive it. See [page 54](#) for charging instructions.*

Docking the Camera

When you are ready to transfer your pictures from the camera to the computer, or charge the Battery Pack, place the camera in the Camera Dock.

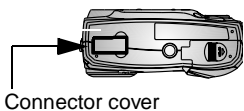

- 1 Turn **off** the camera.
- 2 On the camera bottom, slide the connector cover open.

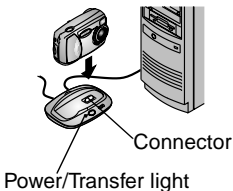

- 3 Place the camera in the Camera Dock and push down to seat the connectors.

The Power/Transfer light glows green when the camera is properly seated.

The camera is now powered by the Camera Dock instead of the camera batteries.

NOTE: If the KODAK EASYSHARE Ni-MH Rechargeable Battery Pack is in the camera, the Camera Dock immediately begins charging (see [page 54](#)).

Charging the Battery Pack

The Battery Pack is not charged when you receive it.

- 1 Turn **off** the camera.
- 2 Make sure the Battery Pack is installed in the camera (see [page 52](#)).
- 3 Place the camera in the Camera Dock (see [page 53](#)).
 - Charging begins immediately.
 - The three green charging lights monitor the charging status:



Charging Lights on Dock II

- ○ ○ battery low
- ● ○ battery partially charged
- ● ● battery fully charged

- Full charging takes about 2.5 hours. After the Battery Pack is fully charged, leave the camera in the Camera Dock to maintain the full charge.
- Charging stops if you turn on the camera. If the camera is left in the Camera Dock with the power on, charging resumes when the camera enters Auto Power-off (see [page 84](#)).

NOTE: The Camera Dock only charges the provided KODAK EASYSHARE Ni-MH Rechargeable Battery Pack. If you place the camera in the Camera Dock with any other type of batteries, rechargeable or not, no charging takes place.

Transferring Pictures

To transfer pictures from your camera to your computer:

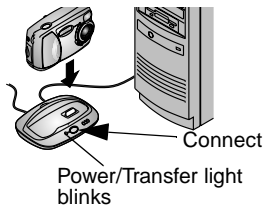

- 1 Place the camera in the Camera Dock.
The camera can be on or off.
- 2 Push the Connect button.

The Power/Transfer light blinks green while the pictures are transferring.

- 3 For details on transferring, organizing, printing, emailing, and editing your pictures, see the Quick Start Guide or the KODAK EASYSHARE Software Help.

NOTE: When your pictures are transferred, leave the camera in the Camera Dock. Eight minutes after the transfer is complete, the Camera Dock resumes charging as necessary.

Caution When Using a Tripod

Do not connect a tripod to the Camera Dock. Remove the camera from the Camera Dock and connect the tripod directly to the camera.

Earlier Camera Dock Model

If you have the KODAK EASYSHARE Camera Dock, not the Camera Dock II, the functionality is exactly the same as described in this chapter. The only difference is that the earlier Camera Dock has one indicator light.

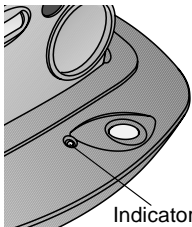

Indicator light

Indicator light status:

Steady green—camera is properly seated in the Camera Dock.

Blinking green— pictures are transferring.

Steady red—Battery Pack is charging.

Blinking red—error condition.

9 Troubleshooting

This chapter contains help for your KODAK EASYSHARE CX4200 Digital Camera or Camera Dock II.

Additional technical information is available in the ReadMe file located on the KODAK EASYSHARE Software CD. For updates to Troubleshooting information, visit our Web site at <http://www.kodak.com/go/cx4200support>.

Troubleshooting—Camera

Camera Problems

Camera		
Problem	Cause	Solution
Camera does not turn on.	Battery is not properly installed.	Remove and reinstall the batteries (page 4).
	Battery is not charged.	Replace or recharge the batteries (page 4 , page 54).
	On/Off switch is not completely in the On position.	Turn the camera off then back on (page 5).

Camera		
Problem	Cause	Solution
Camera does not turn off.	Alkaline batteries were installed in the camera.	DO NOT USE ALKALINE BATTERIES. Turn off the power switch, remove the alkaline batteries, and replace with an approved battery type (page 83). If the power switch is on when you replace the batteries, the camera may not turn back on. In that case, turn the power switch off, then on.
Shutter button does not work.	Camera is not turned on.	Turn on the camera (page 5).
	The camera is processing a picture; the ready light is blinking.	Wait until the light stops blinking before attempting to take another picture.
	The card or internal memory is full.	Transfer pictures to your computer (page 48), delete pictures from the camera (page 28), switch storage locations (page 10), or insert a card with available memory (page 9).

Camera		
Problem	Cause	Solution
Part of the picture is missing.	Something was blocking the lens when the picture was taken.	Keep hands, fingers, or other objects away from the lens when taking pictures.
	Your eye or the picture was not centered correctly in the viewfinder.	Leave space around subject when centering picture in viewfinder.
In Review mode, you do not see a picture on the LCD or do not see the picture you expected.	The camera may not be accessing the correct storage location.	Check the picture storage location setting (page 10).
In Review mode, pictures are displayed as black screens.	The pictures were taken with a different camera or were generated with other software.	Transfer the pictures to the computer (page 48), or delete the picture (page 28).
Picture is too dark.	Flash is not on or did not function.	Turn on the flash (page 16).
	The subject is too far away for the flash to have an effect.	Move so there is no more than the following distance between the camera and the subject: 7.8 ft (2.4 m).
	The subject is in front of a bright light (backlit).	Use Fill flash (page 16) or change your position so the light is not behind the subject.
	Lighting condition is too dark.	Increase exposure compensation (page 21).

Camera		
Problem	Cause	Solution
Camera freezes up when a card is inserted or removed.	Camera detects an error when the card was inserted or removed.	Turn the camera off, then back on. Make sure the camera is turned off before inserting or removing a card.
Picture is too light.	The flash is not needed.	Change to Auto flash (page 16).
	The subject was too close when the flash was used.	Move so there is at least 1.6 ft (0.5 m) between the camera and the subject.
	Lighting condition is too bright.	Decrease exposure compensation (page 21).
Stored pictures are damaged.	The card was removed when the ready light was blinking.	Make sure the ready light is not blinking before removing the card.
Pictures remaining number does not decrease after taking a picture.	Picture does not take up sufficient space to decrease the picture remaining number.	The camera is operating normally. Continue taking pictures.

Camera		
Problem	Cause	Solution
Picture is not clear.	The lens is dirty.	Clean the lens (page 80).
	Subject too close when taking picture.	Move so there is at least 1.6 ft (0.5 m) between the camera and the subject; or turn on Close-up (page 18).
	Camera may be in Close-up (page 18) and the subject is too far away for proper focus.	Turn off Close-up (page 18).
	Subject or the camera moved while the picture was taken.	Hold the camera steady while taking the picture.
	The subject is too far away for the flash to be effective.	Move so there is no more than the following distance between the camera and the subject: 7.8 ft (2.4 m).
Slide show does not run on external video device.	Video Out setting is incorrect.	Adjust the camera Video Out setting (NTSC or PAL, page 40).
	External device is set incorrectly.	Refer to the external device's user's guide.
Slide show does not run on LCD screen.	The camera may not be accessing the correct storage location.	Check the picture storage location setting (page 10).

Camera/Computer Communications

Camera Communications		
Problem	Cause	Solution
The computer cannot communicate with the camera.	There is a problem with the configuration of the USB port on your computer.	See the following file on the KODAK EASYSHARE Software CD: USB.html Or, go to: www.kodak.com/go/camerasupport
	Camera power is off.	Turn on the camera (page 5).
	Battery is not charged.	Replace or recharge the batteries (page 4, page 54).
	Some Advanced Power Management utilities on laptops can turn off ports to save battery life.	See the Power Management section of your laptop user's guide to disable this feature.
	USB cable is not securely connected.	Connect cable to camera and computer port (page 47).
	Software is not installed.	Install the software (page 45).
	There are too many applications running on your computer.	Disconnect your camera from the computer. Close all software applications, reconnect your camera and try again.
	The Battery Monitor or similar software runs constantly.	Close that software before starting the KODAK Software.

Camera Communications		
Problem	Cause	Solution
Cannot transfer pictures to computer. The Add New Hardware Wizard cannot locate drivers.	Software is not installed on computer.	<ul style="list-style-type: none"> ○ Disconnect USB cable, or Camera Dock, from computer. ○ Install KODAK EASYSHARE Software (page 45).
Cannot transfer pictures to computer.	Software is not fully or correctly installed on computer.	<ul style="list-style-type: none"> ○ Disconnect USB cable, or Camera Dock, from computer. ○ Uninstall the software: Start → Settings → Control Panel → Add/Remove Programs ○ Re-install KODAK EASYSHARE Software (page 45). ○ See the KODAK Web site devoted to installing the KODAK EASYSHARE Software on various operating systems (page 73).

MMC/SD Cards

MMC/SD Card		
Problem	Cause	Solution
The camera does not recognize your MMC/SD card.	The card may not be MMC/SD certified.	Purchase a certified MMC/SD card (page 9).
	The card may be corrupt.	Reformat the card (page 41). Caution: Formatting erases all pictures from the card.
	No card is inserted in camera or card is not fully inserted.	Insert a card into the card slot, then push to seat the connector (page 9).
Camera freezes up when a card is inserted or removed.	Camera detects an error when the card was inserted or removed.	Turn the camera off, then back on. Make sure the camera is off when inserting or removing a card.

Camera LCD Messages

LCD Messages		
Message	Cause	Solution
No images to display	There are no pictures in the current storage location.	Change your picture storage location setting (page 10).
Memory card requires formatting	The card is corrupted or formatted for another digital camera.	Insert a new card or format the card (page 41).
Memory card cannot be read (Please format memory card or insert another memory card)		
Internal memory requires formatting	The camera internal memory is corrupted.	Format the internal memory (page 41).
Internal memory cannot be read (Please format internal memory)		
No memory card, Files not copied	There is no card in the camera. Your pictures were not copied.	Insert a card.
Not enough space to copy files	There is not enough space in the location you are copying to (internal memory or the card).	Delete pictures from the location you are copying to (page 28), or insert a new card.
Read only memory card, change to internal memory to capture	The card in the camera is write-protected.	To take a picture, insert a new card or change storage location to internal memory (page 10).

LCD Messages		
Message	Cause	Solution
Memory card is protected (Reset switch on memory card)	Switch on card is in write-protect position.	Reset the switch as shown on LCD.
Card is locked	The card in the camera is write-protected.	To take a picture, insert a new card or change storage location to internal memory (page 10).
Date/Time entry screen appears automatically	This is the first time you turned on the camera; or the batteries have been removed for an extended period of time; or the batteries are exhausted.	Reset the clock (page 7).
High camera temperature. (Camera will be turned off.)	The internal temperature of the camera is too high for the camera to operate. The viewfinder light glows red and the camera will turn off in five seconds.	Leave the camera off for several minutes, then turn it back on. If the message reappears, repeat the sequence above until the message does not appear.
Memory Card is full	There is no more space on the card in the camera.	Delete pictures from the card (page 28), insert a new card, or change storage location to internal memory (page 10).

LCD Messages		
Message	Cause	Solution
Internal Memory is full	There is no more space in the camera's internal memory.	Delete pictures from the internal memory (page 28) or change storage location to Auto and insert card (page 10).
Unrecognized File Format	The camera cannot read the picture format.	Transfer the unreadable picture to the computer (page 48), or delete the picture (page 28).
No Address Book in Camera (Connect with computer to import address book)	No email addresses appear because there is no address book.	Create and copy address book from your computer. See KODAK EASYSHARE Software Help.

Camera Ready Light Status

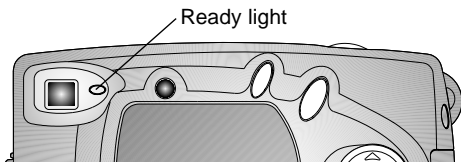

Camera Ready Light		
Light Status	Cause	Solution
Ready light does not turn on and the camera does not work.	Camera is not turned on.	Turn on the camera (page 5).
	Batteries are exhausted.	Replace or recharge the batteries (page 4 , page 54).
	Power switch was on when batteries were reloaded.	Turn camera off, then back on.
Ready light glows steady green.	Camera is on; ready to take a picture.	The camera is operating normally.
Ready light blinks red.	Batteries are low or exhausted.	Replace or recharge the batteries (page 4 , page 54).

Camera Ready Light		
Light Status	Cause	Solution
Ready light glows steady red.	Camera's internal memory or card is full.	Transfer pictures to your computer (page 48), delete pictures from the camera (page 28), switch storage locations (page 10), or insert a card with available memory.
	Camera processing memory is full.	Wait. Resume picture taking when the light turns green.
	Your card is read-only.	Change your storage location to internal memory (see page 10), or use a different card.
Ready light blinks green.	Picture is being processed and saved to the camera.	Camera is operating normally.
Ready light blinks orange.	Flash is not charged.	Wait. Resume picture taking when the light stops blinking and turns green.
	Auto exposure is not locked.	Release the Shutter button and recompose the picture.

Troubleshooting—Camera Dock II

Camera Dock II Problems

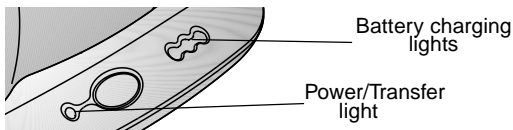

Camera Dock		
Problem	Cause	Solution
Pictures are not transferred to the computer	AC adapter or USB cable is not securely connected.	Check the connections (page 51).
	Software is not installed.	Install the software (page 45).
	There are too many applications running on your computer.	Close all software applications and try again.
	Camera was removed from the Camera Dock during picture transfer.	Replace the camera on the Camera Dock and press the Connect button.
	Connect button was not pressed.	Press the Connect button.

Camera Dock II Light Status



Camera Dock Power/Transfer Light		
Light Status	Cause	Comment
Light glows steady green	Camera is properly seated in the Camera Dock.	The camera and Camera Dock are operating normally.
Light blinks green	Pictures are being transferred to the computer.	
Light is off	Camera is not properly seated in Camera Dock.	Remove the camera and re-seat it (page 53).

Camera Dock Charging Lights		
Light Status	Cause	Comment
 No lights	Charging has not started.	The camera is not in the Camera Dock. Camera is turned on. Turn off to begin charging. Battery in camera is not a KODAK EASYSHARE Ni-MH Rechargeable Battery Pack.

Camera Dock Charging Lights		
Light Status	Cause	Comment
 One green light	Battery is low.	The camera and Camera Dock are operating normally.
 Two green lights	Battery is partially charged.	
 Three green lights	Battery is fully charged.	

Camera Dock Error Light		
Light Status	Cause	Comment
 One blinking red light	Battery Pack is installed incorrectly.	Reinstall the Battery Pack (page 52).
	The Battery Pack or connector pins are damaged.	Check for damage.
	The camera and Battery Pack have been exposed to very high or low temperatures.	Slowly return the camera and Battery Pack to room temperature.
	Battery in camera is not rechargeable or no Battery Pack is installed in camera.	Install a KODAK EASYSHARE Ni-MH Rechargeable Battery Pack (page 52).

10 Getting Help

Helpful Web Links

http://www.kodak.com/go/pcbasics	For help navigating through a WINDOWS-based computer and working with digital pictures.
http://www.kodak.com/go/cx4200support	For help with your KODAK EASYSHARE CX4200 Digital Camera
http://www.kodak.com/go/cx4200downloads	To download the latest camera software and firmware
http://www.kodak.com/go/onetouch	To optimize your printer for prints with truer, vibrant colors
http://www.kodak.com/go/camerasupport	For product support on cameras, software, accessories, and more
http://www.kodak.com/go/cx4200accessories	To purchase a full range of digital camera accessories
http://www.kodak.com/go/EasyShareSWHelpWin http://www.kodak.com/go/EasyShareSWHelpMacOS9 http://www.kodak.com/go/EasyShareSWHelpMacOSX	To get help installing the KODAK EASYSHARE software.
http://www.kodak.com/go/register	To register your new CX-4200 Digital Camera.

Help in this User Guide

See [Chapter 9, Troubleshooting](#), for help with problems you may have with your camera, camera/computer connections, Camera Dock, or MMC/SD cards.

Software Help

For help with the software included on the KODAK EASYSHARE Software CD, see the Quick Start Guide or the KODAK EASYSHARE Software Help.

Telephone Customer Support

If you have questions concerning the operation of the software or camera, you may speak directly to a customer support representative.

Customer support hours vary by location.

Before You Call

Before you call to speak to a customer support representative, please have the camera connected to your computer, be at your computer, and have the following information available:

Operating system _____

Processor speed (MHz) _____

Computer model _____

Amount of memory (MB) _____

Exact error message you received _____

Version of installation CD _____

Camera serial number _____

Telephone Numbers

Australia	1800 147 701
Austria/Osterreich	0179 567 357
Belgium/Belgique	02 713 14 45
Brazil	0800 15 0000
Canada	1 800 465 6325
China	800 820 6027
Denmark/Danmark	3 848 71 30
Ireland/Eire	01 407 3054
Finland/Suomi	0800 1 17056
France	01 55 1740 77
Germany/Deutschland	069 5007 0035
Greece	00800 441 25605
Hong Kong	800 901 514
India	91 22 617 5823
Italy/Italia	02 696 33452
Japan	81 3 5644 5500
Korea	0798 631 0024
Netherlands/Nederland	020 346 9372
New Zealand	0800 440 786
Norway/Norge	23 16 21 33
Philippines	1 800 1 888 9600
Portugal	021 415 4125
Singapore	800 6363 036

Spain/España	91 749 76 53
Sweden/Sverige	08 587 704 21
Switzerland/Schweiz/Suisse	01 838 53 51
Taiwan	0080 861 008
Thailand	001 800 631 0017
UK	0870 243 0270
United States	1 800 235 6325
Outside the United States	585 726 7260
International Toll Line	+44 131 458 6714
International Toll Fax Number	+44 131 458 6962

These telephone numbers change occasionally; for the most up-to-date listings, visit: <http://www.kodak.com/US/en/digital/contacts/DAIInternationalContacts.shtml>.

11 Appendix

This appendix serves as a resource for technical information about your KODAK EASYSHARE CX4200 Digital Camera, KODAK EASYSHARE Camera Dock II, MMC/SD cards, batteries, and available accessories.

Camera Specifications

Specifications—KODAK EASYSHARE CX4200 Digital Camera		
Pixel Resolution (by Quality setting)	Best - 2.0 MP	1632 x 1232, 1/5 JPEG compressed
	Better - 1.0 MP	1184 x 888, 1/5 JPEG compressed
	Good - 0.5 MP	816 x 616, 1/5 JPEG compressed
Color	24-bit, millions of colors	
Picture File Format	EXIF 2.2 (JPEG compression)	
Picture Storage	16 MB internal memory MMC (MultiMedia) or SD card	
Viewfinder	Reverse Galilean	
ISO Sensitivity	Automatic (100, 200)	
Flash Range	1.6 to 7.8 ft (0.5 to 2.4 m)	
Tripod Socket	.25 in. (6 mm) threaded	
Video Out	NTSC or PAL	
Operating Temperature	32 to 104 ^o F (0 to 40 ^o C)	

Specifications—KODAK EASYSHARE CX4200 Digital Camera

Power	Batteries	2 Lithium, AA 2 KODAK AA Digital Camera Batteries KODAK CRV3 Lithium Battery 2 Ni-MH, AA rechargeable Alkaline batteries not recommended
	Battery Pack, Camera Dock only	KODAK EASYSHARE Ni-MH Rechargeable Battery Pack, recharge in Camera Dock only. Dock provides power to the camera.
	3V, DC power in	AC adapter not included
Lens	Type	Optical quality glass
	Maximum Aperture	f/4.5
	Zoom, 2X	2X Digital zoom
	Focal Length	39 mm (equivalent to 35 mm camera) .22 in (5.6 mm) actual
	Focus Distance	29.5 in. (750 mm) to infinity
	Focus Distance, Close-Up	7.9 to 11.8 in. (200 to 300 mm)
Dimensions	Width	1.6 in. (40 mm)
	Length	4.3 in. (109 mm)
	Height	2.5 in. (64 mm)
Weight	7.1 oz (200 g) without batteries or card	

Original Factory Settings—Camera

Feature	Factory Setting
Date/Time	2001/1/1; 12:00
Date Stamp	Off
Exposure Compensation	0
Flash	Auto
Image Storage	Auto
Liveview	Off
Orientation Sensor	On
Print Quantity	1
Quality	Best ★★★ - 2.0 MP (highest resolution)
Quickview	On
Self Timer	Off
Slide Show Interval	5 seconds
Video Out	NTSC

Upgrading Your Software and Firmware

Take advantage of the latest enhancements to your Kodak software and camera firmware. Software refers to the applications included on the KODAK EASYSHARE Software CD. Camera firmware is the internal software that runs on the camera.

To download the latest versions of software and firmware, go to: <http://www.kodak.com/go/cx4200downloads>

Tips, Safety, Maintenance

- Always follow basic safety precautions. Refer to the “Important Safety Instructions” booklet packed with your camera.
- Do not allow any chemicals, such as suntan lotion, to come into contact with the painted surface of the camera.
- If the camera has been subjected to inclement weather or you suspect water has gotten inside the camera, turn off the camera and remove the battery and card. Allow all components to air-dry for at least 24 hours before using the camera again.
- Clean the lens and LCD:
 - 1 Blow gently on the lens or LCD to remove dust and dirt.
 - 2 Moisten the lens or LCD by breathing lightly on it.
 - 3 Wipe the lens or LCD gently with a soft, lint-free cloth or an untreated lens-cleaning tissue.

Do not use cleaning solutions unless they are designed specifically for camera lenses. **Do not wipe the camera lens or LCD with chemically treated eyeglass lens tissue. It may scratch the lens.**
- Clean the outside of the camera by wiping with a clean, dry cloth. Never use harsh or abrasive cleaners or organic solvents on the camera or any of its parts.
- Service agreements are available in some countries. Please contact a dealer of Kodak products for more information.
- For digital camera disposal or recycling information, visit the KODAK Website <http://www.kodak.com/global/en/service/tib/tib4357.shtml>; please contact your local authorities or, in the US, visit the Electronics Industry Alliance Web site: www.eiae.org.

Picture Storage Capacities

Picture file sizes can vary. You may be able to store more or fewer pictures. Purchase cards on our Web site at <http://www.kodak.com/go/cx4200accessories>.

	Store this many pictures at:		
	Best ★★★	Better ★★	Good ★
16 MB internal memory	23	48	95
8 MB MMC/card	12	23	48
16 MB card	23	48	95
32 MB card	48	95	192
64 MB card	95	192	383
96 MB card	144	288	576
192 MB card	288	576	1152

Locating Pictures on an MMC/SD Card

Pictures stored on MMC/SD Cards use a standard agreed upon by many camera manufacturers. This lets you use the cards in different cameras. If you use a card reader to retrieve your files, the following description of the card file structure may be helpful.

MISC folder—contains the order files created when you use the Share feature to tag files for printing, emailing, and as Favorites.

SYSTEM folder—used for updating camera firmware.

DCIM folder—root level folder, contains the 100K4200 folder. Each time you turn on the camera or insert a different card, any empty folders within the DCIM folder are removed.

100K4200 subfolder—contains all the pictures on the card.

Card File Naming Conventions

- Pictures are named DCP_nnnn.JPG, and are numbered in the order in which they are taken. The first picture is named DCP_0001.JPG; the highest number allowed is DCP_9999.JPG.
- When a card contains a picture named DCP_9999.JPG in the \DCIM\100K4200 folder, subsequent pictures appear in a new folder (\DCIM\101K4200), beginning with picture DCP_0001.JPG.
- Even if you transfer pictures to the computer or delete pictures from the camera, the camera continues to use consecutive numbers for all subsequent pictures. For example, if the last picture taken was DCP_0007.JPG and you delete it, the next picture you take is named DCP_0008.JPG.
- When you insert a different card into your camera, the next picture number is defined by incrementing the higher of the last picture taken by the camera, or the highest existing picture number in the folder.
- If you use the card in a camera other than the KODAK EASYSHARE CX4200 Digital Camera, and that camera manufacturer adheres to this file structure standard, the \DCIM folder contains a folder named by that camera. For more information, refer to the documentation that accompanied that camera.

Using Your Batteries

- **Replacement Types**—your camera can use the following battery types:
 - 2, 1.5 volt AA lithium batteries
 - 1, KODAK CRV3 Lithium Battery *
 - 1, KODAK EASYSHARE Ni-MH Rechargeable Battery Pack, rechargeable in the KODAK EASYSHARE Camera Docks *
 - 2, 1.2 volt AA Nickel Metal Hydride (Ni-MH) batteries, rechargeable *
 - 2, KODAK Digital Camera Batteries*
- * Purchase these batteries on our Web site at <http://www.kodak.com/go/cx4200accessories>.
- For acceptable battery life, and to make sure your camera operates dependably, **we do not recommend or support alkaline batteries.**
- **To lengthen battery life**, limit the following activities:
 - Using Liveview (using the LCD as the viewfinder, see [page 14](#))
 - Reviewing your pictures on the LCD (see [page 27](#))
 - Excessive use of the flash
 - Dirt on battery contacts can affect battery life. Wipe the contacts with a clean, dry cloth before loading batteries in the camera.
 - **NOT ALL BATTERIES ARE CREATED EQUAL!** Battery life depends significantly on battery age, usage conditions, type, and brand. Digital camera requirements are very demanding on batteries. Not all batteries perform well under these challenging conditions. For a comparison of different battery types, refer to the Battery Option sheet that is included with your camera.
 - Battery performance is reduced at temperatures below 41 °F (5 °C). Carry spare batteries when using your camera in cold weather, and keep them warm until you are ready to take pictures. Do not discard cold batteries that do not work. When they return to room temperature, they may be usable.

Battery-Saving Features

The LCD or camera turn off when the camera has been inactive.

Camera state	If no activity, LCD turns off after:	If no activity, camera turns off after:	To reactivate camera:
LCD Off	N/A	8 minutes (Auto Power-off)	Press any button
LCD On; Liveview, Review, any menu screen	1 minute		
Quickview on	5 seconds		
Slide show	1 minute after slide show ends		
Any state	N/A	1 hour (Camera off)	Turn power switch off and on

Optional AC Adapter

To save battery power, purchase a KODAK Digital Camera AC Adapter, 3-Volt on our Web site at <http://www.kodak.com/go/cx4200accessories>.

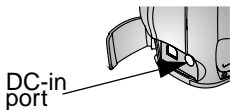

- Use the AC Adapter, 3-Volt when reviewing, copying, and transferring pictures.
- Connect the 3-Volt adapter to the camera's DC-in port and to a power outlet.



CAUTION:

Do not use the Digital Camera AC Adapter, 3-Volt with a KODAK EASYSHARE Camera Dock; it is NOT compatible.

Camera Dock II Specifications

Specifications—KODAK EASYSHARE Camera Dock II		
Communication with computer	USB	Cable included with KODAK EASYSHARE Cameras
Dimensions (without insert)	Width/Depth/Height	5.9 in. /4.1 in. /1.4 in. (150 mm/104 mm/35 mm)
	Weight	5.5 oz (156 g)
Indicator lights	Power/Transfer	Indicates operating/transferring pictures
	Charging, 3 lights	Indicate charging and error conditions
Input voltage		7 \pm 0.7 V DC
Power	DC input	AC adapter included with Camera Dock

Regulatory Information

FCC Compliance and Advisory

This device complies with Part 15 of the FCC Rules. Operation is subject to the following two conditions: 1) this device may not cause harmful interference, and 2) this device must accept any interference received, including interference that may cause undesired operation.

This equipment has been tested and found to comply with the limits for a Class B digital device, pursuant to Part 15 of the FCC Rules. These limits are designed to provide reasonable protection against harmful interference in a residential installation.

This equipment generates, uses, and can radiate radio frequency energy and, if not installed or used in accordance with the instructions, may cause harmful interference to radio communications. However, there is no guarantee that interference will not occur in a particular installation.

If this equipment does cause harmful interference to radio or television reception, which can be determined by turning the equipment off and on, the user is encouraged to try to correct the interference by one or more of the following measures: 1) reorient or relocate the receiving antenna; 2) increase the separation between the equipment and the receiver; 3) connect the equipment to an outlet on a circuit different from that to which the receiver is connected; 4) consult the dealer or an experienced radio/TV technician for additional suggestions.

Any changes or modifications not expressly approved by the party responsible for compliance could void the user's authority to operate the equipment. Where shielded interface cables have been provided with the product or specified additional components or accessories elsewhere defined to be used with the installation of the product, they must be used in order to ensure compliance with FCC regulation.

Canadian DOC Statement

DOC Class B Compliance—This Class B digital apparatus complies with Canadian ICES-003.

Observation des normes-Class B—Cet appareil numérique de la classe B est conforme à la norme NMB-003 du Canada.

VCCI Class B ITE

この装置は、情報処理装置等電波障害自主規制協議会（VCCI）の基準に基づくクラスB情報技術装置です。この装置は、家庭環境で使用することを目的としていますが、この装置がラジオやテレビジョン受信機に近接して使用されると、受信障害を引き起こすことがあります。
取扱説明書に従って正しい取り扱いをして下さい。

English translation:

This is a Class B product based on the standard of the Voluntary Control Council for Interference from Information Technology Equipment (VCCI). If this is used near a radio or television receiver in a domestic environment, it may cause radio interference. Install and use the equipment according to the instruction manual.

Index

A

about

camera information, 42

picture information, 32

AC adapter, optional, 84

accessories, buying, 73

adjusting

exposure, 21

picture quality, 22

resolution, 22

alkaline batteries, 4

arrow button, 5

auto

flash, 16

power-off, 84

storage location, 10

B

backlit scenes, 21

batteries

alkaline, 4

charging Battery Pack, 54

extending battery life, 83

loading Battery Pack, 52

loading CRV3, 4

power level icon, 25

replacement types, 83

tips, 83

with Camera Dock, 49

button

delete, 15, 28

five-way/zoom, 5

flash, 16

menu, 10, 34, 35, 36

review, iv

share, 34, 35, 36

shutter, 13

C

cables

power, Camera Dock, 51

power, camera optional, 84

USB, connect camera, 47

USB, connect Dock, 51

video, 30

Camera Dock

charging Battery Pack, 54

docking camera, 53

earlier model, 56

installing insert, 50

lights status, 71

package contents, 49

- power connection, 51
 - specifications, 85
 - transferring pictures, 55
 - USB connection, 51
 - using, 49
 - Canadian compliance, 87
 - capture mode
 - accessing menus, 19
 - overview, 11
 - returning from other modes, 19
 - taking pictures, 13
 - card, memory, 9, 10, 81, 82
 - caring for your camera, 80
 - changing storage location, 10
 - charging Battery Pack, 54
 - charging lights, Camera Dock II, 54, 71
 - cleaning camera, lens, 80
 - clock, setting, 7
 - close-up scenes, 18
 - communication problems, 62
 - compensation, exposure, 21
 - computer
 - connecting camera, 47
 - connecting Camera Dock, 51
 - system requirements, 43
 - transferring pictures, 48, 55
 - connecting the camera
 - first, important note, 47
 - to Camera Dock, 53
 - to computer, 47
 - with USB cable, 47
 - connecting the Camera Dock, 51
 - contents
 - Camera Dock package, 49
 - copying pictures
 - memory to card, 31
 - to computer, 48, 55
 - cover, lens, iii, 5
 - CRV3 battery, installing, 4
 - custom insert, 50
 - customer support numbers, 74
 - customizing camera settings, 37
- D**
- date
 - imprinting on pictures, 23
 - setting clock, 7
 - date stamp, 23
 - DCIM folder, card, 81
 - defaults
 - changing print quantity, 38
 - original factory settings, 79
 - deleting

- by formatting, 41
- during quickview, 15
- last picture, 15
- pictures, 28
- protected pictures, 28
- digital pictures, using, 48
- digital zoom, 17
- display problems, 59
- displaying pictures, 25, 29
- distance, close-up, 18
- dock insert
 - custom, 3
 - universal, 50
- Dock, Camera. See Camera Dock
- downloading pictures, 48, 55

E

- EASYSHARE Software, installing, 45
- email icon, 25
- emailing pictures, 35
- error light, Camera Dock, 72
- error messages, 65
- exposure, adjusting, 21
- external video device
 - setting video out, 40
 - viewing pictures on, 30

F

- favorites
 - icon, 25
 - tagging for, 36
- FCC compliance, 86
- features, camera overview, iii–iv
- file names, card, 82
- fill flash, 16
- firmware
 - upgrading, 73, 79
 - version, 42
- five-way arrow button, 5
- flash features, 16
- focus distance, close-up, 18
- folders, card, 81
- formatting, memory & cards, 41

G

- guidelines, battery, 83

H

- help
 - telephone support, 74
 - troubleshooting camera, 57
 - troubleshooting Camera Dock, 70
 - web links, 73
 - with computers, 73

I

icons

- camera status, 8
- capture menus, 19
- picture information, 25
- review menus, 26
- setup menus, 37
- share menus, 33

image storage menu, 10

information

- about camera, 42
- about pictures, 32
- product support, 73

insert, for Camera Dock

- custom, 50
- universal, 49, 50

installing

- Battery Pack, 52
- CRV3 battery, 4
- insert, Camera Dock, 50
- KODAK Digital Camera
 - batteries, 4
- MMC/SD card, 9
- software, 45

internal memory

- change storage location, 10
- format, 41

internet, helpful web links, 73

K

KODAK Digital Camera

Batteries, 4

KODAK EASYSHARE Software, 48

KODAK software

- getting help, 48, 74
- installing, 45
- transferring pictures, 48

Kodak web sites, 73

L

language, setting, 6

large print, this user guide, 1

LCD (Liquid Crystal Display)

- display languages, 6
- error messages, 65
- picture location icon, 8
- reviewing last picture, 15
- status bar, 8
- turning off quickview, 39
- turning on liveview, 39
- using as viewfinder, 14
- viewing pictures, 27

lens

- cleaning, 80
- cover, built-in, iii, 5
- specifications, 78

lights

- Camera Dock, 56
- Camera Dock II, 54, 71–72
 - ready, camera, 68
 - self-timer, camera, iii, 20
- links, world wide web, 73
- liveview
 - turning on, 39
 - using LCD as viewfinder, 14
- loading
 - Battery Pack, 52
 - CRV3 battery, 4
 - insert, Camera Dock, 50
 - MMC/SD card, 9
 - software, 45
- loop, slide show, 30
- M**
- MACINTOSH**
 - installing software on, 45
 - system requirements, 43, 44
- magnify picture, 32
- maintenance, camera, 80
- memory
 - internal or card, 10
 - storage location setting, 10
- memory card
 - inserting, 9
 - storage capacities, 81
- menu button, 10, 34, 35, 36
- menus
 - capture mode, 19
 - image storage, setting, 10
 - review mode, 26
 - setup mode, 37
 - share mode, 33
 - tagging pictures, 33
 - taking pictures, 19
- MISC folder, card, 81
- MMC/SD card
 - file name conventions, 82
 - file structure, 81
 - formatting, 41
 - inserting, 9
 - picture location, 10
 - printing from, 48
 - setting storage location, 10
 - storage capacities, 81
 - troubleshooting
 - problems, 64
- mode indicator icon, 25
- modes
 - camera, overview, 11
 - capture, 13, 19
 - review, 25
 - setup, 37
 - share, 33
- monitor, requirements, 43
- multi-up, viewing

thumbnails, 27
multiple pictures, viewing, 27

N

NTSC, video out setting, 40

O

OK button, 5
on/off switch, iii, 5
orientation sensor, 24
overview
 camera features, iii–iv
 camera modes, 11

P

package contents
 Camera Dock, 49
PAL, video out setting, 40
picture location icon, 25
picture number icon, 25
pictures
 close-ups, 18
 copying, 31
 date imprint, 23
 deleting, 28
 downloading, 48, 55
 e-mailing, tagged, 35
 file naming, 82
 information, viewing, 32

 locating on card, 82
 magnifying, 32
 printing, 48
 printing tagged, 34
 protecting, 28
 quality settings, 22
 reviewing, 15, 25
 status info, 25
 storage capacity, 81
 storage location, 10
 tagging, 34, 35, 36
 taking, 13
 transferring to
 computer, 48, 55
 using on computer, 48
 viewing, 27, 30

power

 Camera Dock, 51
 optional AC adapter, 84
 turning camera on, 5
power light, Camera Dock, 71
powerdown, automatic, 84
print icon, 25
print sizes, per quality
setting, 22
printing
 changing default quantity, 38
 from a card, 48
 optimizing printer, 73

- pictures, 48
 - tagged pictures, 34
 - this user guide, 1
- protect icon, 25
- protecting pictures, 28

Q

- quality
 - print, digital zoom, 17
 - settings, 22, 81
- quickview
 - deleting pictures, 15
 - reviewing last picture, 15
 - turning off, 39

R

- ReadMe file, 57
- ready light
 - status, 68
 - taking pictures, 13
- red-eye, flash, 16
- regulatory information, 86, 87
- removable memory card, 9
- replacement batteries, types, 83
- requirements
 - MACINTOSH OS, 43, 44
 - WINDOWS-based OS, 43
- resolution, setting, 22
- return to previous menu, 38

- review mode
 - getting there, 25
 - menus, 26
 - overview, 11
 - picture information, 25
 - reviewing pictures, 25
- reviewing pictures
 - as you take them, 15
 - deleting, 28
 - magnify, 32
 - on lcd, 27
 - picture information, 32
 - protecting, 28
 - slide show, 29
- running slide show, 29

S

- safety, 80
- SD card, inserting, 9
- self-timer, 20
- service and support, 74
- setting
 - clock, 7
 - date and time, 7
 - flash, 16
 - language, 6
 - NTSC/PAL, 40
 - picture quality, 22
 - picture storage location, 10

- resolution, 22
 - self-timer, 20
 - video out, 40
 - setup mode
 - getting there, 37
 - overview, 11
 - returning to previous, 38
 - using, 37
 - share button, 34, 35, 36
 - share mode
 - email tagging, 35
 - getting there, 33
 - overview, 11
 - print tagging, 34
 - tagging favorites, 36
 - shutoff, auto, 84
 - shutter button
 - problems, 58
 - self-timer delay, 20
 - taking pictures, 13
 - sleep mode, 84
 - slide show
 - continuous loop, 30
 - problems, 61
 - running, 29
 - software
 - help, 48, 74
 - installing, 45
 - upgrading, 73, 79
 - specifications
 - camera, 77
 - Camera Dock II, 85
 - MACINTOSH OS, 43, 44
 - WINDOWS-based OS, 43
 - status
 - bar, 8
 - camera, 8
 - screen icons, 8
 - storage capacity, memory, 81
 - storage location, 10
 - strap, wrist, 4
 - support, technical, 73–76
 - System folder, card, 81
 - system requirements
 - MACINTOSH OS, 43, 44
 - WINDOWS-based OS, 43
- T**
- tagging pictures
 - for email, 35
 - for favorites, 36
 - for print, 34
 - print quantity default, 38
 - share mode, 33
 - when and where, 33
 - taking pictures
 - capture mode, 13
 - changing options, 19

- close-up, 18
 - menus, 19
 - quality settings, 22
 - using LCD as viewfinder, 14
- telephone support, 74
- television, viewing pictures, 30
- thumbnails, viewing on lcd, 27
- time, setting, 7
- timer, shutter delay, 20
- tips
 - battery guidelines, 83
 - maintenance, 80
 - ReadMe file, 57
 - safety, 80
- transfer light, Camera Dock, 71
- transferring pictures to
 - computer, 48, 55
- trash can, deleting
 - pictures, 15, 28
- tripod, connecting, iii, 55
- troubleshooting problems
 - camera, 57
 - Camera Dock, 70
 - camera ready light, 68
 - communications, 62
 - error messages, 65
 - MMC/SD card, 64
- turning camera on and off, 5

- U**
 - universal insert, 50
 - upgrading software,
 - firmware, 73, 79
 - URLs, Kodak web sites, 73
 - USB cable, connector, iii, 47, 51

- V**
 - VCCI compliance, 87
 - video out, setting, 30, 40
 - viewfinder
 - lens, iii
 - taking pictures, 13
 - using LCD instead, 14
 - viewing
 - camera information, 42
 - picture information, 32
 - viewing picture
 - after taking, 15
 - magnified, 32
 - on an external device, 30
 - on lcd, 27

- W**
 - Web links, 73
 - WINDOWS**
 - installing software, 45
 - system requirements, 43
 - wrist strap, attaching, 4

Z

zoom

button, 5

digital, 17